

TÖYÖTÖMI

VENTED HEATING SYSTEM



FQ-C70 / FQ-S70

IMPORTANT

- 1) READ AND UNDERSTAND INSTRUCTIONS BEFORE INSTALLING OR USING HEATER.
- 2) RETAIN INSTRUCTIONS IN A SAFE PLACE FOR FUTURE REFERENCE.
- 3) CHECK LOCAL AUTHORITY & BUILDING CODES FOR INSTALLATION REQUIREMENTS.

SECTION A: SPECIFICATIONS

Model:	FQ-C70 / FQ-S70
Heater Efficiency:	92.4% (1)
Heat Rating:	High - 7.00 kW (23,800 BTU/h) Med - 4.05 kW (13,800 BTU/h) Low - 2.18 kW (7,400 BTU/h)
Fuel Consumption:	High - 0.791 L/h Med - 0.457 L/h Low - 0.246 L/h
Fuel System:	External tank (2)
Fuel Type:	Paraffin only
Dimensions (W × H × D):	840 × 745 × 450 mm (FQ-C70) 760 × 608 × 483 mm (FQ-S70)
Weight:	40 kg (FQ-C70) 36 kg (FQ-S70)
Vent Pipe Hole:	70 ~ 80 mm diameter
Maximum Length of Vent Pipe System:	3 m, 3 bends or less (Section I “Installation”)
Electrical Rating:	220 Volts AC, 50/60 Hz Preheat - MAX 260/260 W Burning - MAX 55/52 W (FQ-C70) 44/46 W (FQ-S70)

- (1) Heat and vaporized water are produced by fuel combustion. Heat rating does not account for heat loss due to condensation of water vapor.
- (2) External tank to be purchased separately. (Consult your supplier for options.)

SAFETY FEATURES

Your heater is equipped with a number of integral safety features. Please familiarize yourself with these features. If the heater shuts down due to the operation of any safety device, ensure the problem is identified and corrected. Note that normal combustion flames inside the combustion chamber, can be seen through some “peep holes”, located in the front bottom left hand corner of the hot air outlet louvers.

1. Flame Sensor

Heater will automatically stop all operations if ignition fails or if flame fails during combustion, in order to prevent fuel overflow. Error code will be displayed on the digital indicator.

2. Fuel Strainer

Special strainer catches any dirt or impurities present in the fuel before it is sent to the burner.

3. Overheat Protector

Automatically stops all operations if heater cabinet reaches abnormally high temperature due to motor malfunction or abnormal combustion.

4. Fully Vented System

Flue Pipe system provides outside air for combustion and vents all combustion products to outdoors.

SECTION B: SAFETY TIPS FOR OPERATION

CAUTION: Heater and vent pipe system must be properly installed before operation.

Please follow instructions under “Installation”, Section I.

- Children should be supervised to ensure that they do not play with the appliance.
- DO NOT move the heater when it is burning or still hot.
DO NOT refill nor service the heater when it is burning or still hot.
- Position the front of the heater at a distance of minimum 1.5 m from walls, curtains, furniture, spray can and gas cylinder. DO NOT store the fuel tank near the heater.
- DO NOT use the heater in dusty rooms. You will not have optimum burning in such rooms. DO NOT use the heater in the immediate surrounding of a bath, a shower or a swimmingpool.
- Switch off the heater, before you leave or go sleeping. Unplug the heater as well, when you go away for a longer period of time (e.g. holidays).
- Store and move fuel only in suitable tanks and jerrycans.
- Make sure that the fuel is not exposed to heat or extreme temperature changes. ALWAYS store the fuel in a cool, dry and dark place (sunlight will affect the quality).
- NEVER use the heater in places where harmful gasses or fumes may be present (e.g. exhaust gasses or paint fumes).
- Be aware that the grid and the top plate become hot. If the appliance is covered there is a risk of fire.
- ALWAYS make sure that there is sufficient ventilation.
- This appliance is not intended for use by persons (including children) with reduced physical, sensory or mental capabilities, or lack of experience and knowledge, unless they have been given supervision or instruction concerning use of the appliance by a person responsible for their safety.
- This appliance can be used by children aged from 8 years and above and persons with reduced physical, sensory or mental capabilities or lack of experience and knowledge if they have been given supervision or instruction concerning use of the appliance in a safe way and understand the hazards involved.
- Children shall not play with the appliance.
- Cleaning and user maintenance shall not be made by children without supervision.
- DO NOT stay near the heater for a long time.
- Due to high surface temperatures, keep heater away from children, furniture and clothing while in operation.
- DO NOT insert the fingers or other objects into the heat chamber or guard.
- NEVER use any fuel other than Paraffin. NEVER USE GASOLINE. Use of gasoline can lead to uncontrollable flames, resulting in destructive fire.
- To prevent abnormal operation and prolong heater life, be sure to perform routine maintenance. (See Section F)
- NEVER store or transport fuel in other than a metal or plastic container that is acceptable for fuel and clearly marked “PARAFFIN”. NEVER store fuel in the living space. Defective electrical devices and batteries must be kept separate from household waste. Ensure that there is effective recycling where possible. Ask your local council or dealer for expert advice on recycling.

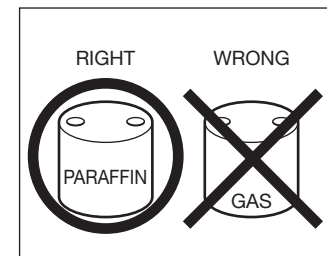
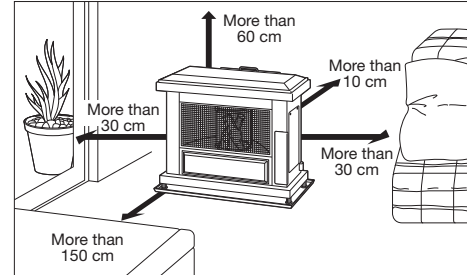

SECTION C: FUEL GUIDE

The heater is designed for use with Paraffin. Use of low-quality fuel will cause burner performance to drop, leading to abnormal combustion and reduced heater life.

Purchase only Paraffin, in non-red cans reserved exclusively for fuel and marked accordingly with the word “PARAFFIN”. Always store your fuel in a separate area from where you store gasoline for your power equipment to avoid accidental use of gasoline in your heater.

What to Buy . . .

- ALWAYS: Clean and high-quality Paraffin.
- ALWAYS: Fuel free of contaminants, water or cloudiness.
- NEVER: Gasoline, alcohol, white gas, camp stove fuel or additives.
- NEVER: Yellow or sour-smelling fuel.

How to Store It . . .

- ALWAYS: Store in a clean container, clearly marked PARAFFIN.
- ALWAYS: Store away from direct sunlight, heat sources or extreme temperature changes.
- NEVER: In a glass container, or one that has been used for other fuels.
- NEVER: For longer than six months. Begin each heating season with fresh fuel; discard at the end of season.
- NEVER: In the living space.

Why It is Important . . .

Pure, clean fuel is essential for safe and efficient heater operation. Poor quality or contaminated fuel can cause:

- Excess tar deposits on burner and flue pipe
- Incomplete combustion
- Reduced heater life

Use of a highly volatile flammable fuel such as gasoline can produce uncontrollable flames, creating a severe fire hazard.

SECTION D: OPERATING CONTROLS AND PART NAMES

Before using heater, familiarize yourself with the following operating controls and part names.

FQ-C70

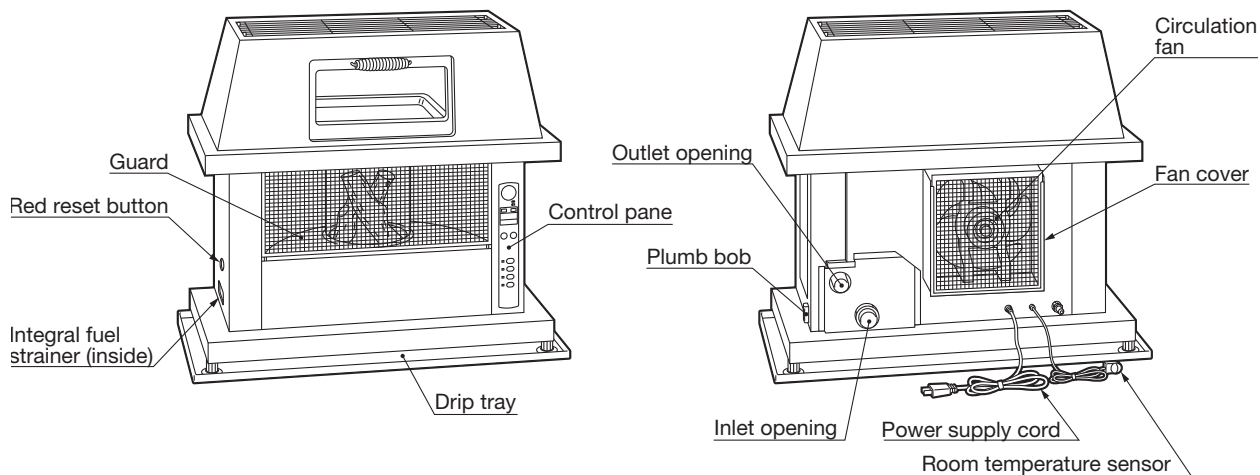

FQ-S70

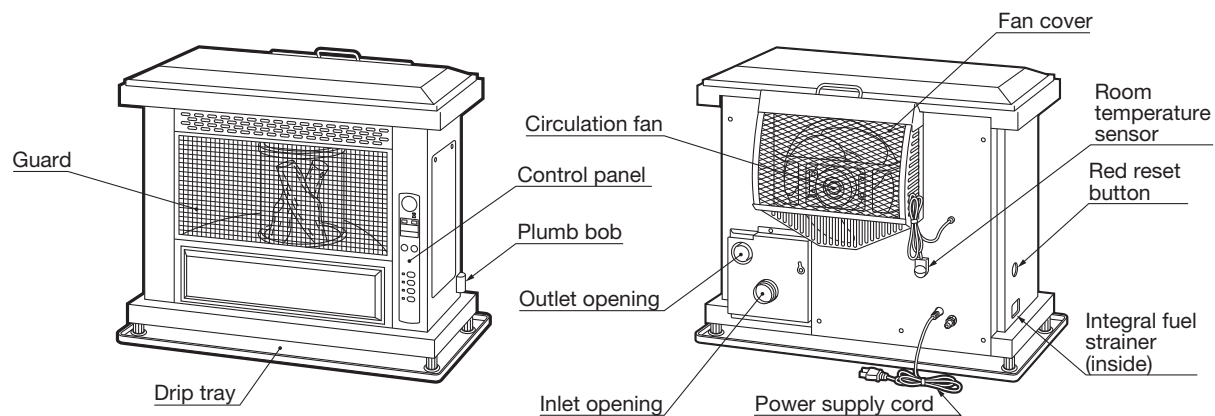

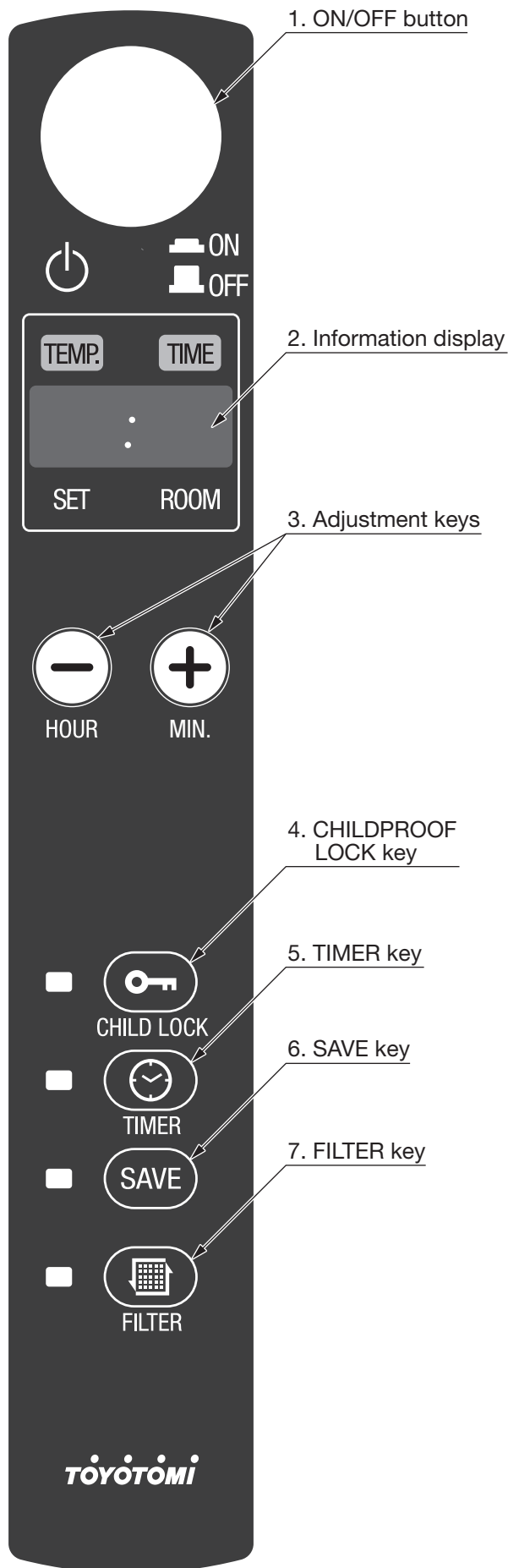

1. ON/OFF button:
The main button to turn the heater on and off. Switch it "ON" to activate the heater. Combustion will start after 2-6 minutes in pre-heating period.
2. Information display:
Displays the clock, set temperature, room temperature and error codes.
3. Adjustment keys:
Select the desired temperature during operation.
4. CHILDPROOF LOCK key:
The key turns CHILD LOCK operation mode on and off.
5. TIMER key:
Allows you to switch on the heater automatically at a preset time.
6. SAVE key:
When the room exceeds the selected setting by approximately 2°C, the heater will automatically shut off. As the room temperature becomes lower than the setting temperature, the heater will automatically restart to maintain the desired temperature.
7. FILTER key:
This key is for releasing the filter lamp.
When the filter lamp shows on, it indicates "clean the fan filter" (*refer to SECTION F*).
To release the filter lamp, press the FILTER key for more than 3 seconds.

SECTION E: OPERATION

BEFORE IGNITION

1. FILLING FUEL

Fill the external tank using a fuel pump and clean off any spilled fuel.
When there is not enough fuel in the tank, the heater will extinguish automatically.
When this occurs, you will hear the buzzer and E-2 or E-6 is displayed.

2. OPEN THE VALVE(S)

Open the valve(s) of the external fuel tank.

3. START THE FUEL FLOW

If using heater for the first time, press the red reset button in order to send fuel to the fuel sump and release.

NOTE: Make sure there is no fuel leakage from the fuel line or joints.
Also make sure fuel tank is not too high. See installation instructions.

4. CONNECT THE HEATER

Connect heater into a proper electrical outlet. (refer to SECTION A). On digital indicator pre-set "Two Dashes" will be showing.

NOTE: Do not connect to an outlet shared with other appliances.

5. SET CLOCK

IMPORTANT: The clock on the heater must always be set to the correct time.
It is only possible to set the correct time, when the heater is connected to the mains and not burning.

Use the adjustment keys to set the time.

First press either of the two keys to switch (the CLOCK lamp and the information display will start blinking). Next, set the hours using the key on the left (-HOUR) and the minutes using the key on the right (+MIN.). After approximately 10 seconds the blinking will stop and the setting will be locked. After switching off the heater, the clock time will be displayed.

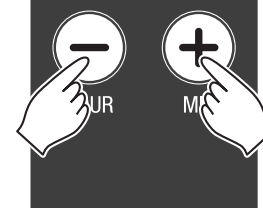
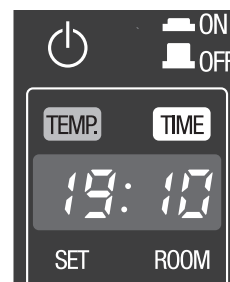
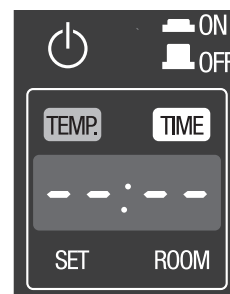
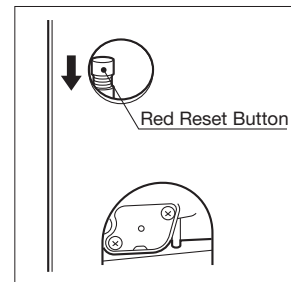

OPERATION

1. TURNING HEATER ON

1. Press ON/OFF button to "ON" position. You will hear the buzzer and the ON/OFF button will be blinking. The current room temperature and the set temperature will be shown on the digital indicator. TEMP. lamp will be lit and then blower motor and ignition will start. ON/OFF switch will continue to blink during the preheating time.

2. After approx. 2 – 6 minutes ignition will take place. (*) After ignition, ON/OFF switch will change blinking to continuous. Circulation fan will turn on approx. 2minutes after ignition.

NOTE: (*) Pre -heating depends on the room temperature.

Room temperature:

under 0°C	6	minutes
0°C - 15°C	4	minutes
15°C	2	minutes

When room temperature is lower than 0°C, ignition will take place after 7 minutes.

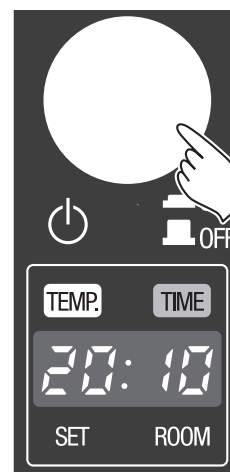

NOTE: When the heater does not ignite after once or twice igniting operation, do not ignite many times and contact your dealer to avoid abnormal combustion. If the abnormal combustion occurs, press ON/OFF button to "OFF" position and wait until the accumulating fuel burns out. When this occurs, do not unplug the heater.

2. SETTING THE ROOM TEMPERATURE

The temperature setting can only be adjusted, when the heater is burning. Use the adjustment keys to adjust the temperature. First press either of the two buttons to switch on the function (the TEMP. light will start blinking). Next, adjust the temperature using the key on the right (+MIN.) to higher the temperature and on the left (-HOUR) to lower the temperature. After approximately 10 seconds the TEMP. light will stop blinking and setting will be locked. The available temperature settings range is from 10°C at minimum to 32°C at maximum.

When room temperature is higher than 35°C, *H* (Hi) is displayed. When room temperature is lower than -9°C, *L* (Lo) is displayed.

The operating mode is automatically controlled in accordance with the room temperature detected by the room temperature sensor. The heater works in the "HIGH" operating mode until the room temperature has reached the set temperature. When the room temperature reaches the chosen setting, the heater automatically will switch to the "MED" or "LOW" operating mode in order to maintain the desired temperature.

NOTE: When you use the heater at first, the original setting is 20°C.

SET ALTITUDE

If the heater is used at a height of 1000 - 1500 m, use the altitude mode.

1. Make sure that the heater is switched off.
2. Press the (-HOUR) key and (+MIN.) key at the same time for more than 3 seconds. "iE" is shown in the information display. If the room temperature is shown, it also can continue to set altitude.
3. Press the TIMER key and SAVE key at the same time for more than 3 seconds while the information display indicates "iE". You will hear the buzzer and "H L H i" will be blinking on the information display for 3 seconds and the display will turn back to the original state.

To release the altitude mode, start the procedure from 1 again.

NOTE: In the event of power failure or disconnection of heater, the altitude setting will remain.

CAUTION: Do not use the heater at a height of over 1500 meters.

THE CORRECT USE OF 'SAVE'

The 'SAVE' function allows you to limit the temperature. You can set the 'SAVE' function when the heater is burning. When this function is activated, the heater will automatically switch off, when the room temperature exceeds the set temperature by 2°C. Subsequently, when the room temperature has dropped again to the set temperature, the heater will automatically switch on again. 'SAVE' setting will be activated by pressing the key. The SAVE lamp will light up. Switch off the function by pressing the SAVE key once again.

NOTE: Without the 'SAVE' setting, your heater will maintain the set temperature by approximation as well, by adjusting its heating capacity. 'SAVE' is an economical setting, which you can use when, for instance, you are not present in the room or to keep it frost-free.

CHILD PROOF LOCK OPERATION

The childproof lock can be used to prevent children accidentally changing the heater settings. When the heater is burning and the childproof key is on, the heater can only be switched off. Other functions are blocked then. If the heater has already been switched off, the childproof lock also prevents accidental ignition of the heater.

1. Press the CHILD LOCK (CLEAR) button for more than 3 seconds to set the childproof lock while in operation or not operation. CHILD LOCK lamp will light.

To release the child lock operation, press the CHILD LOCK (CLEAR) button for more than 3 seconds.

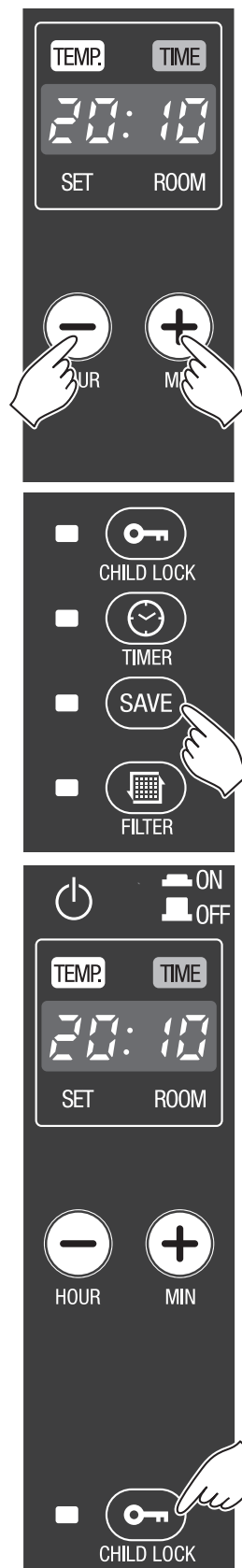

TIMER OPERATION

The timer allows you to switch on the heater automatically at a preset time. In order to switch on the timer, the correct time must have been set and the heater should be off. Follow the procedure below:

1. Press the TIMER key. The information display will show "-- --" and TIMER lamp will start blinking.
2. Use the adjustment keys to set the desired time at which ignited. Use the key on the left (-HOUR) to set the hours (interval of 1 hour) and the key on the right (+MIN.) to set the minutes (interval of 10 minutes).
3. Press the ON/OFF button while TIMER lamp is blinking to switch on Timer operation.
4. After a short while, TIMER lamp will light that the timer has been set and the information display will show the current time.
To clear the timer setting, press the ON/OFF button once.

NOTE: The heater stops the operation and the heater will automatically start again by activating timer operation if you press TIMER key during normal operation.

NOTE: You can check the set time for 10 seconds by pressing TIMER key while not in operation.

NOTE: If you cannot set the timer, press the TIMER key and start the procedure again.

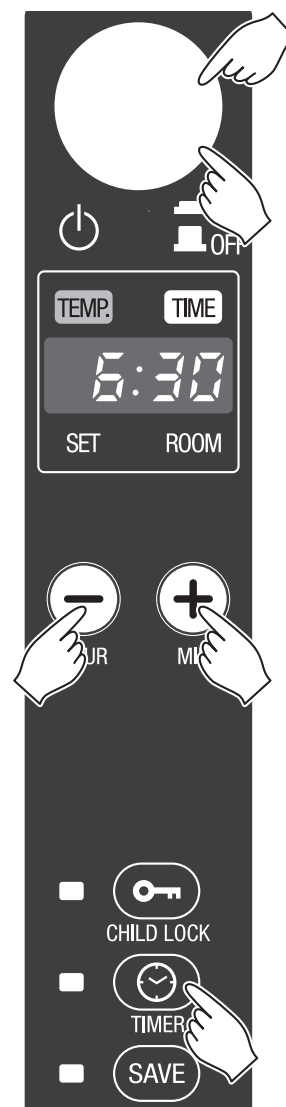
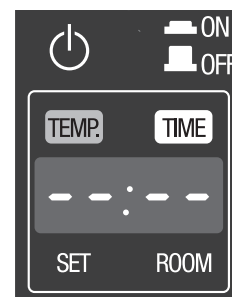

AUTOMATIC CLEANING MODE

When the heater has been burning continuously for two hours at its highest setting, the burner will automatically start an auto clean procedure. The display will show the auto cleaning code 01:05 running back to 01:01. The procedure takes 5 minutes to clean the burner automatically while the heater will burn at its lowest setting. When the burner is clean again, the heater will automatically switch back to the highest setting again.



TURNING HEATER OFF

Press ON/OFF button to “OFF” position. ON/OFF button will blink and will go out. The information display will show current time. Circulation fan and blower motor continue to run for approx. three (3) minutes to cool down the heater.

NOTE: ON lamp goes out when the fan stops. DO NOT disconnect the plug from the outlet until the fan stops.

NOTE: When you go out, make sure to switch off.

NOTE: When the heater is not used for a long time, make sure to disconnect the plug from the outlet.

NOTE: Do not ignite the heater soon after extinguishing. Reignite after the heater cools down.

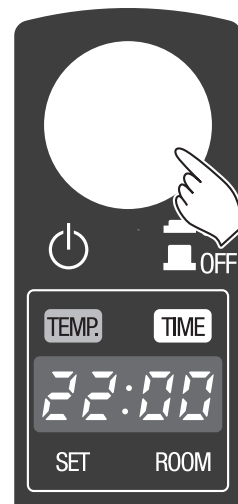

HOW TO USE THE OVEN

Set the tray as the accessory into the oven.

The inside temperature of the oven will vary depending on the operating mode of the heater. When the heater operates in “HIGH” mode, the inside temperature will be approx. 180°C. When the heater operates in “LOW” mode, the inside temperature will be approx. 100°C.

Use the handle for oven to open and close the oven as it will be hot during the operation (refer to Section I).

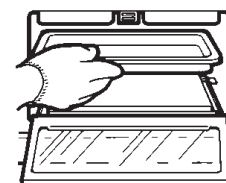

SECTION F: ROUTINE MAINTENANCE

CAUTION: Be sure to disconnect heater before performing any checks or cleaning.

CAUTION: Allow heater to cool completely before cleaning or maintenance.

FOR OPTIMUM HEATER PERFORMANCE, THE PARTS SHOWN BELOW SHOULD BE CLEANED REGULARLY:

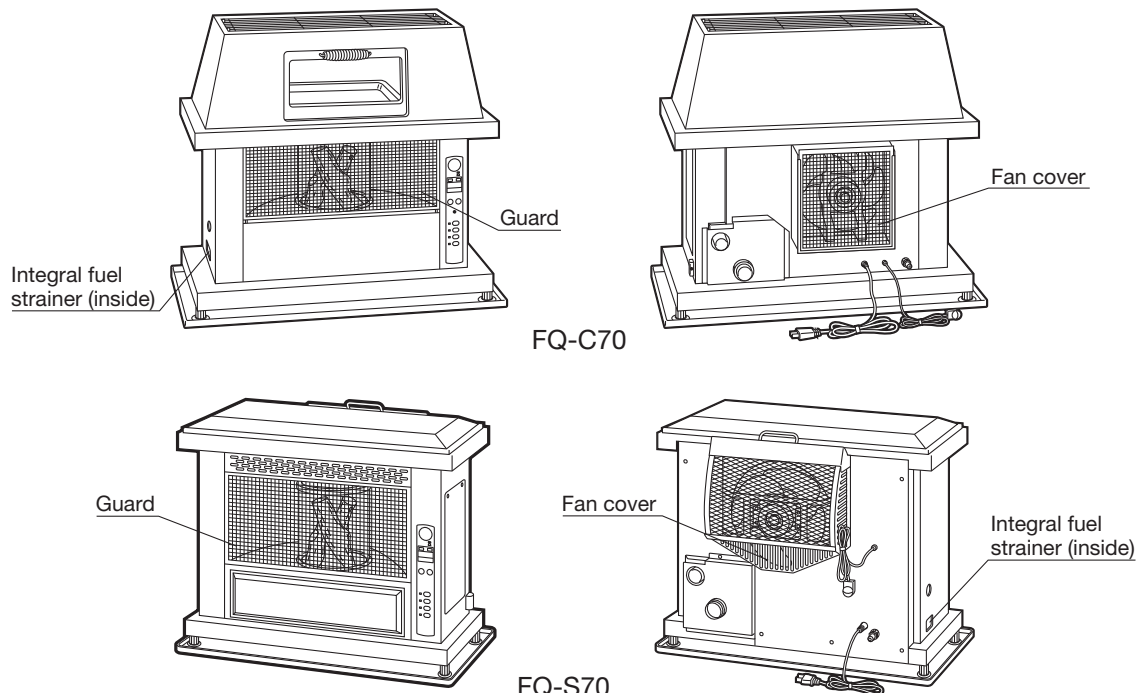

1. Clean Guard (ONCE A WEEK)

Dust and stains should be wiped off on the Guard with a damp cloth.

2. Clean Circulation Air Filter (ONCE A WEEK)

A mesh filter is located on heater cabinet rear side.

Once a week slide the filter up to remove and it should be vacuumed clean.

3. Check for Fuel Leaks (REGULARLY)

Make it a habit to check for any sign of fuel leakage along the fuel line and at all joints.

Fuel leaks may lead to risk of fire.

4. Check Flue Pipe Area (ONCE A WEEK)

Check the flue pipe joint to make sure connection is firm.

Use a vacuum cleaner to remove any dust or pet hair.

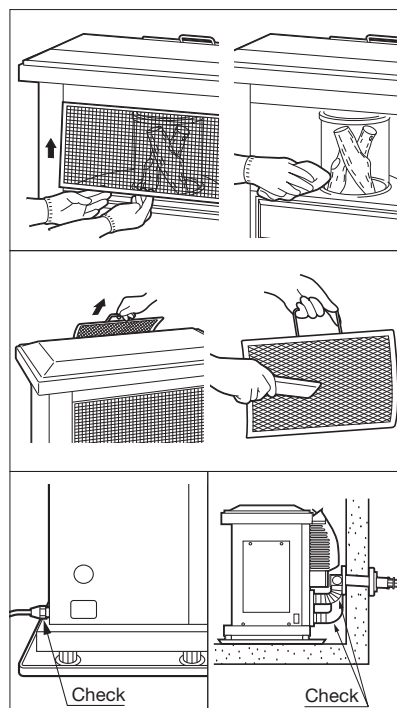
**5. Clean Fuel Strainer (ONCE A MONTH)**

The strainer of the fuel sump should be cleaned once a month and before storing heater at the end of each season.

- Close the valve(s) of the separate fuel tank.
- To catch the fuel which will drain out, set an oil catch such as cardboard below the strainer cover, with a small container under it.
- Loosen the two screws from the strainer cover and remove.
- Remove the strainer and wash with fuel.
- Return the strainer to its original position. Replace strainer cover and screw to secure.
- Wipe away any spilled fuel.
- Open the valve(s) of separate fuel tank. Check for fuel leakage.

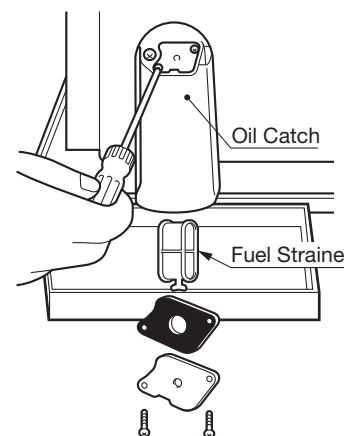

NOTE: Be sure to unscrew the drain screw to remove all remaining fuel from the fuel sump at the end of each season.

6. Check Glass Cylinder (ONCE A MONTH)

If the glass cylinder is sooted or cracked, contact your dealer for replacement.

7. Check Ceramic Log (ONCE A MONTH)

If the ceramic log is cracked, contact your dealer for replacement.

8. Recommended Periodic Maintenance

As a state-of-the-art furnace, your heater requires periodic inspection and service by an authorized technician to insure optimum, trouble free performance. This inspection should include: a combustion check; flue pipe check; burner assembly check; cleaning all necessary parts and replacing gaskets as needed. Please ask your authorized TOYOTOMI dealer for details and scheduling.

SECTION G: TROUBLESHOOTING

BEFORE REQUESTING A SERVICE CALL

The following symptoms are normal during operation of the heater.

	CONDITION	REASON
When heater is started or extinguished.	White smoke or smell inside home when the heater is first used.	Machine oil used in factory assembly, or transit dust burns off the surfaces of the burner or heat exchanger.
	Flashing flames visible in viewing window for a few minutes after ignition.	The burner is cold and igniter is kept running for a while after.
	Irregular metallic "cracking" noises when when heater is ignited or extinguished.	Expansion / contraction of hot metal components within the heater warming and cooling.
	Warm air is not discharged as soon as ignited.	Delay is to prevent nuisance cool air.
	Audible "chugging sound" from fuel pump.	Air is in the fuel pump (No fuel). At first "Start Up" the rapid "chugging noise", may continue for a minute or two, until air is purged from the pump*.
When heater is in operation.	Regular pulse "Ticking" noise from heater.	Sound of fuel pump in normal operation.
	Heat chamber or heat exchanger can be seen through the air outlet louver's glowing red hot.	Normal
	Occasional yellow flickering in blue flame.	Normal

*If rapid "chugging" sound from fuel pump does not cease and if heater shuts OFF.....

1. Push Fuel Sump Red Reset Button. (refer to SECTION E) DO NOT hold down.
2. Insure that all valves (including fire valve) are open.
3. Insure external fuel tank has fuel and fuel filters are clean.

ERROR CODE	INFORMATION	WHAT TO DO
E-0	Power interrupted.	Re-ignite the heater.
E-2	Ignition safety feature is activated. / No fuel.	Contact your dealer. / Refill fuel.
E-6	Extinguished during operation. / No fuel.	Contact your dealer. / Refill fuel.
E-8	Blower motor malfunction.	Contact your dealer.
E-12	Overheating safety feature is activated.	Clean the air filter and remove dust.
E-13	Burner thermistor malfunction.	Contact your dealer.
	Excess fuel in the burner.	Contact your dealer.
E-22	Ignition failure three times.	Contact your dealer.
E-23	Primary flame rod (Flame sensor) is malfunction and/or dirty.	Consult your dealer.
-- : --	Timer is not setting.	Set the timer.
Hi	Room temperature is higher than 35°C. Position of room temperature sensor is not correct.	Check the position of room temperature sensor.
Lo	Room temperature is lower than -9°C. Room thermistor malfunction or disconnected.	Check the position of room temperature sensor.

SECTION H: LONG TERM STORAGE

At the close of each heating season, or when you do not plan to use your heater for an extended period, the following procedures are recommended.

1. As the end of the season approaches, calculate your fuel purchases so that you can use up all the fuel you have on hand. When fuel is stored for over six months, its quality may deteriorate. The use of such fuel will have an unfavorable effect on heater operation.
2. If your heater needs any service or repair, now is the time to call your dealer and get it done before storage. That way your heater will be ready for immediate use when the next heating season begins.
3. If you plan to store your heater in place,
 - (a) Disconnect power supply.
 - (b) Close the main tank valve.
 - (c) Remove all fuel from the fuel sump and clean the fuel strainer. (See “Clean Fuel Filter” on SECTION F)
 - (d) Wipe off any stains or dust on heater with a damp cloth, then wipe once again using a dry cloth.
 - (e) Cover heater completely with a large plastic bag to protect from dust.
4. To store heater in another location,
 - (a) Disconnect heater.
 - (b) Close the main tank valve.
 - (c) Remove all fuel from the fuel sump and clean the fuel strainer.
 - (d) Disconnect fuel line and flue pipe from the heater.

NOTE: Fuel remaining in the fuel line may flow out when fuel line is disconnected. Have a container ready to catch drainage.

- (e) Remove any soot accumulated in the flue pipe using a brush and/or vacuum cleaner.
- (f) Wipe off any stains or dust on heater with a damp cloth, then wipe once again using a dry cloth.
- (g) Put the heater in the original shipping box, and store in a dry place. If original shipping box is not available, cover the heater completely with a large plastic bag to protect from dust during storage.
- (h) Cover exhaust and air intake openings of the flue pipe by using optional caps.
(Part #17212661 and #17212656)

TRANSPORTATION

Take the following measures to avoid fuel leakage during the transportation of the heater.







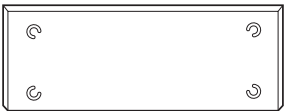
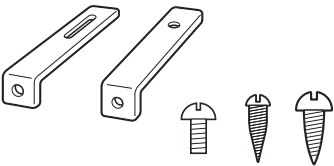
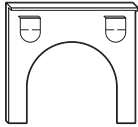

- ALWAYS move the heater in an upright position.
- ALWAYS drain fuel from the fuel sump before transportation.

SECTION I: INSTALLATION

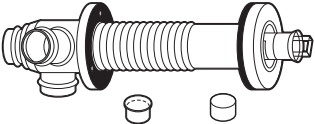
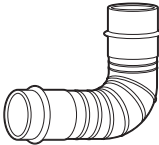
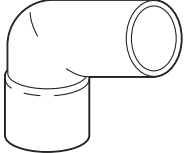
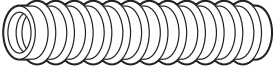
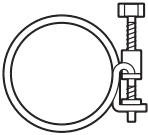
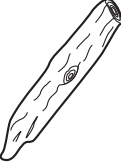
GENERAL DESCRIPTION: The heater is designed to be installed in an outside wall so the full advantage of installation simplicity can be made with the “Flue Pipe”, which eliminates the need for tall chimney type flues. No hearth or fire surround is required.

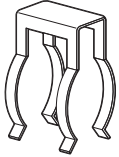
STANDARD INSTALLATION PARTS

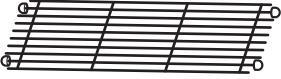
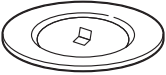
The following standard installation parts are enclosed with heater. For alternate installation methods, you may need to purchase additional accessories which are available from your TOYOTOMI dealer. See “Accessory Parts”.

 <p>Drip Tray (1) (PART #17303814)</p>	 <p>Wall Bracket (2 sets) (PART #17212589) Bind Tapping Screw (2) (PART #17187555) Wood Screw (2) (PART #17206066) (1) (PART #17206066) (Room temperature sensor) Pan Head Tapping Screw (2) (PART #17208678)</p>	
 <p>Pipe Stopper (1) (PART #17185278)</p>	 <p>Wood Screw (3) (PART #17206066) Truss Head Tapping Screw (2) (PART #17160351) (Only for FQ-C70)</p>	 <p>Flue Pipe (1) (PART #17224296) Exhaust Air Cap (1) (PART #17212661) Intake Air Cap (1) (PART #17212656)</p>
 <p>Bent Joint (L) (1) (PART #17212598)</p>	 <p>L-shaped Hose (2) (PART #17212598)</p>	 <p>Inlet Hose (1) (PART #17212693)</p>
 <p>Hose Band (2) (PART #17212677) (Hose Clamp)</p>	 <p>Ceramic log (3) (PART #17212505)</p>	 <p>Log supporter (1) (PART #17303815)</p>
 <p>Pipe Holder (1) (PART #17212685)</p>	 <p>Canopy guard (1) (PART #17303893) (for FQ-C70) (PART #17303993) (for FQ-S70)</p>	<p>(FQ-C70)</p>  <p>Top guard assembly (1) (PART #17303891) Only for FQ-C70</p>
<p>(FQ-C70)</p>  <p>Heat chamber lid (1) (PART #17212510)</p>	<p>(FQ-C70)</p>  <p>Tray (1) (PART #17303825) Only for FQ-C70</p>	<p>(FQ-C70)</p>  <p>Handle for oven (1) (PART #17303828) Only for FQ-C70</p>

INSTALLATION ADVICE

- Intake air and exhaust flue pipe openings of the Flue Pipe must be fully exposed to outside. The Flue Pipe must not vent into a chimney, garage, basement, under-floor or ceiling cavity, or any enclosed area, or be installed vertically, because the Flue Pipe is a "Heat Exchanger" which causes condensate to form in the exhaust pipe, and which must drain to outside.

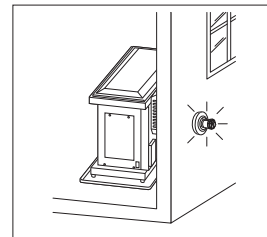

- Install Flue Pipe Note the volume and temperature of the hot exhaust gas that the exhaust pipe discharges to outside, is minimal, and does not normally present any problems.

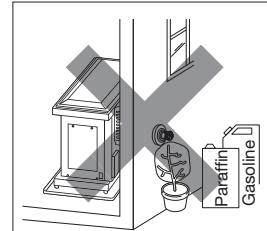

- Before making a hole in the wall for the Flue Pipe ensure the wall cavity is free of electrical wires, gas pipes and other obstacles. Drilling a 5 mm "pilot hole" from inside enables the final hole (and any associated "mess") to be completed from outside.

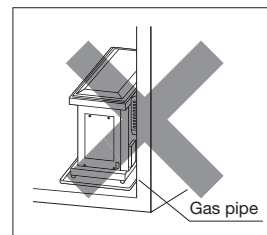

- DO NOT install Flue Pipe where the air supply or exhaust gas outlet might become covered by snowdrifts, fouled by outdoor debris, or directly exposed to winds over 50 kph.

IMPORTANT:
In areas of heavy snow falls, ground surface clearance must be increased according to average snow falls.

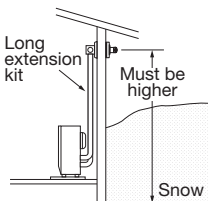

IMPORTANT:
In open area with strong wind, a wind break may be necessary.

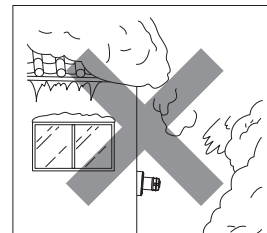
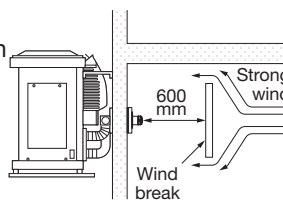

- NEVER install the Flue Pipe below the heater.

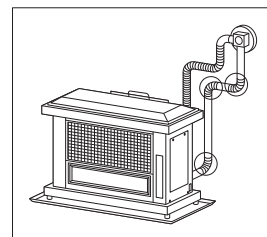
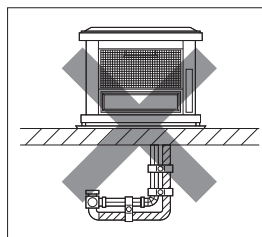
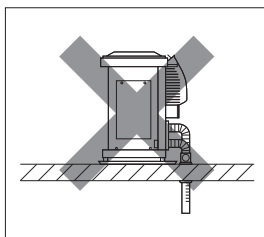

- Total length of any Extension Pipe Kits (accessories L, M or S) between heater and Flue Pipe must not exceed 3 m, with not more than 3 × 90° bends.

NOTE: When using Extension Pipe Kits type L, M or S always insulate hot exhaust pipe with the insulating cloth cover supplied. (More insulation may be required by Local Authority).

- For all heater installations, the Flue Pipe must always be installed. It must be horizontal with slight fall to outside ... **NEVER vertically.**

INSTALLATION OF HEATER AND FLUE PIPE

- A) Before commencing any installation work, check that the proposed installation will comply with Building Code requirements and Local Consent Authority rules that may apply to vented heaters in your area. (Check your Local Authority website, or consult your Installer / Supplier.)
- B) The Flue Pipe is designed to be installed through the wall of any conventional building cladding, including Brick, Hebel, Linear, Gibraltar and Plaster Board, Tiles, Weatherboard, Plastered Polystyrene, and metal profiles etc.
- C) The heater is designed to be operated at altitudes up to 1000 m, above sea level. For installation at altitudes between 1000 m and 1500 m, adjustments by authorized serviceperson is necessary. Consult your supplier for advice.
1. Select heater location. Ensure minimum clearances as indicated below between heater and nearest combustible materials. Provide service access to clean the rear circulation air filter, integral fuel strainer and reset button.

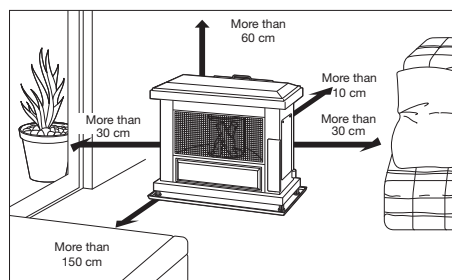

Fig. 1

2. Ensure the outdoor flue discharge area is clear of anything that might be affected by the hot flue exhaust gas. (See Fig. 2 and 3.)
The Flue Pipe (as in Fig. 2), is for wall thickness from 130 mm to 320 mm.

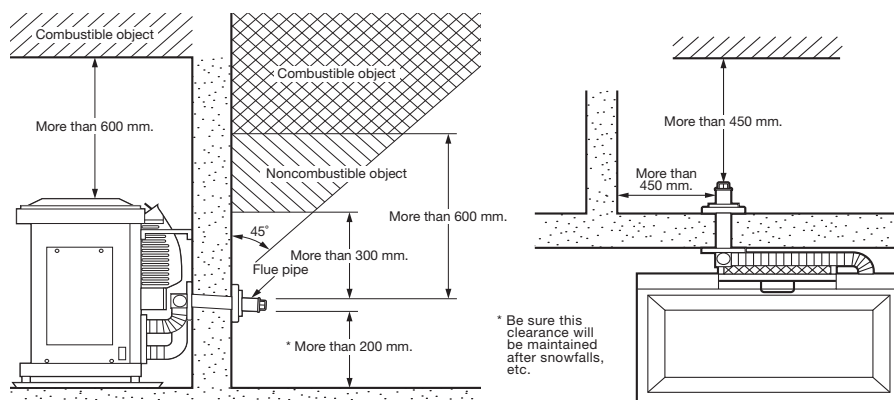
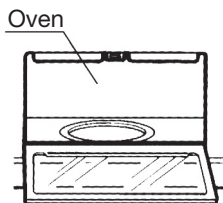

Fig. 2

Fig. 3

Flue Pipe Installation

3. Install the ceramic log.
(for FQ-C70)
a. Open the door of the oven.



(for FQ-S70)

- a-1. Remove four (4) screws from top plate to remove the top plate.

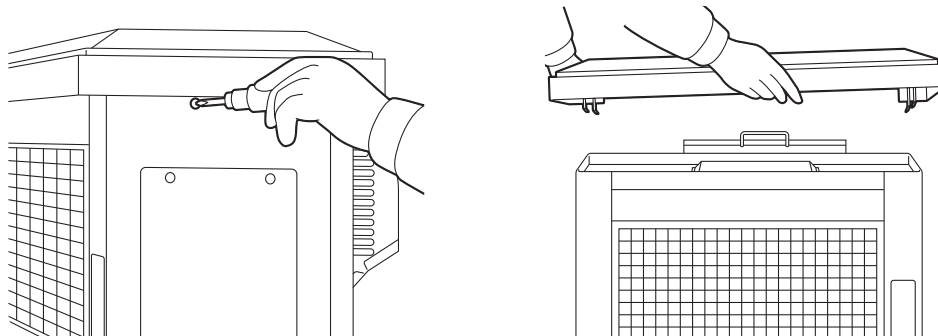

- a-1. Remove four (4) screws from canopy guard to remove the canopy guard. Remove the heat chamber lid from the heat exchanger.

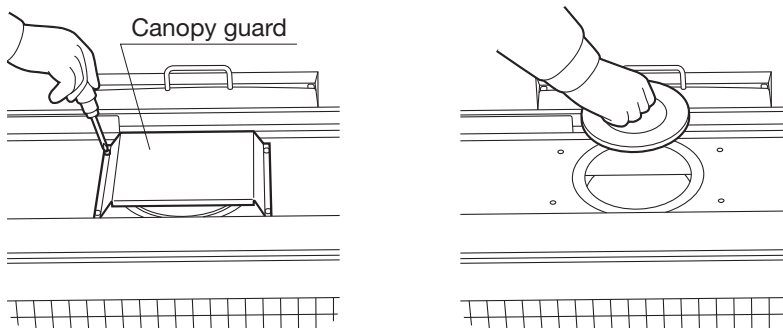

<Canopy Guard>

<Heat Chamber Lid>

(for both model)

- b. Gently insert the ceramic logs into three (3) brackets inside of burner properly. After inserting the ceramic logs, install log supporter on the upper holes of the ceramic logs. Adjust the log supporter so as to place the logs at the center of the burner.

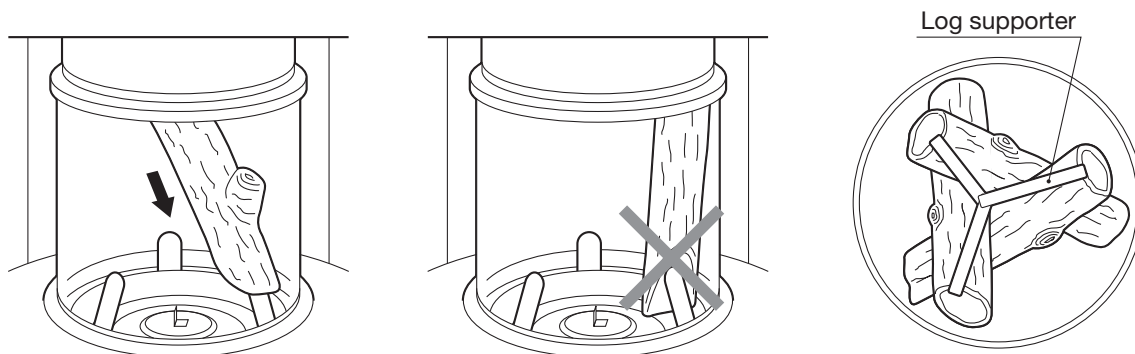

Correct

Wrong

Top View

4. Make sure the position of the heater is level by using the plumb bob located at the right side of the heater. The plumb bob weight should be within the circle. If the plumb bob weight is not within the circle, adjust the heater legs until the plumb bob weight is within the red circle.

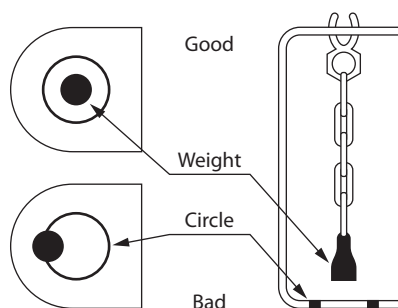

Plumb bob as viewed from above

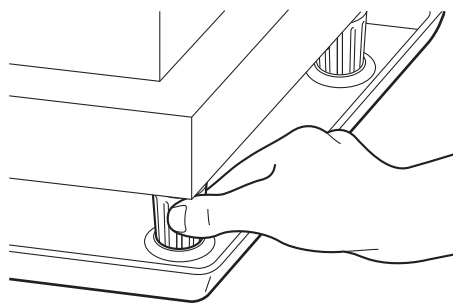

5. A room temperature sensor is provided with approx. 2.5 meters long extension wire. It is located on the rear of the cabinet. Make sure that the extension wire is not touching the exhaust pipe. The room temperature sensor can be installed with a wood screw. Screw down the wood screw provided with the heater into the desired location on the wall. Hook the back of the room temperature sensor.

NOTE: Choose a location for the sensor that is not in the path of direct sunlight, drafts or the flow of warm air from the heater.

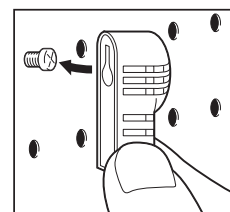

6. **THE HANDLE FOR OVEN (only for FQ-C70)**

Use the handle for oven to open and close the oven as it will be hot during the operation. When you do not use the handle for oven, hang it on the hole on the right side panel.

CAUTION: DO NOT touch directly as the oven will be hot.

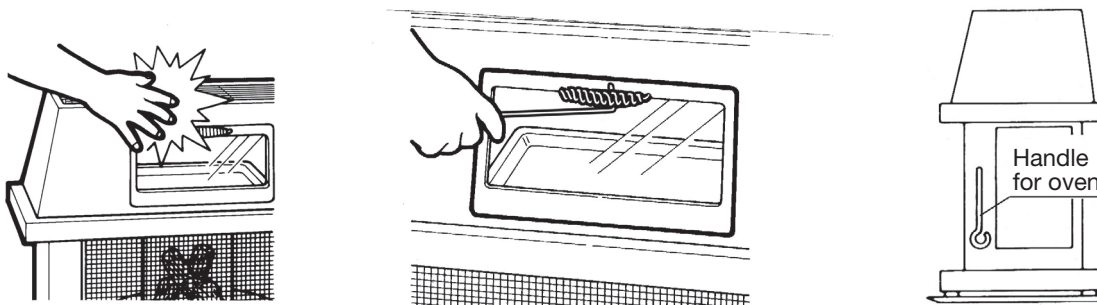

Read installation manual before installing heater.

TOYOTOMI CO., LTD.

5-17, Momozono-cho, Mizuho-ku, Nagoya, 467-0855 Japan
<http://www.toyotomi.jp>

Rev. 08/18

Printed in Japan
2273002060