

TOYOTOMI

PORTABLE KEROSENE HEATER OPERATION AND MAINTENANCE INSTRUCTIONS

Model **RCA-2800**
(Type C)

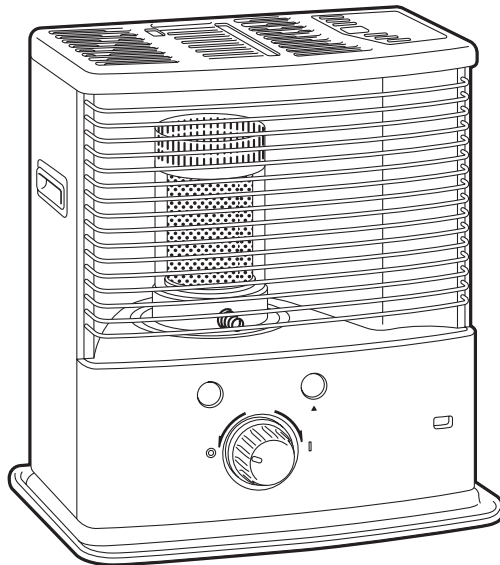

SAFETY TIPS

BEFORE OPERATING YOUR HEATER, PLEASE review these safety tips:

WARNING

RISK OF EXPLOSION

1. Never use any fuel other than clean kerosene (paraffin).

Never use gasoline (petrol). Use of gasoline (petrol) can lead to uncontrollable flames resulting in destructive fire. Even kerosene (paraffin) contaminated with small amounts of gasoline (petrol), or similarly volatile materials, can be hazardous. Never use a can for kerosene (paraffin) that has previously been used for gasoline (petrol), paint thinner, methylated spirit, or solvents.

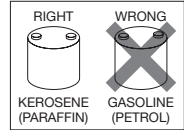

2. Never refill heater fuel tank when heater is operating or still hot. To do so may cause a “flash back“ of flame to the fuel container, resulting in injury to yourself and your property.



3. Never use heater in areas where flammable vapors or gases may be present. Especially avoid use of heater where gasoline (petrol), naphtha, acetone or other volatile solvents are in the air, or whose containers are open. Such vapors could be ignited by the heater, resulting in fire and/or explosion.

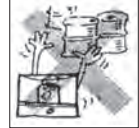

4. Never fill heater fuel tank in living space. Fill heater tank outdoors. Never overfill your heater. Always replace heater tank cap securely after refueling. Spillage of kerosene (paraffin) produces strong odor which is hard to remove. Spillage on carpet can be ignited if match or some other ignition source contacts it.

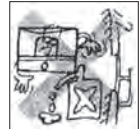

5. Never store or transport kerosene (paraffin) in other than a metal or plastic container that is (1) acceptable for kerosene (paraffin), (2) non-red in color, and (3) clearly marked, “KEROSENE (PARAFFIN)”. Never store kerosene (paraffin) in the living space. Picking up a gasoline (petrol) can by mistake when fueling is a major cause of heater fires.



Store the kerosene (paraffin) out of reach of children in a safe container, marked “KEROSENE” (“PARAFFIN”).

WARNING

RISK OF BURNS OR FIRE

1. Observe the heater carefully for 15-20 minutes after start-up. Problems of improper adjustment of wick height or improperly seated heat chamber should become evident during this warm up period.

NOTE: Carefully follow the instructions for lighting and adjusting the flame.



2. Due to high surface temperatures, keep away from children, furniture and clothing.

3. Do not use heater to heat or boil water or as a cooking appliance. Do not place cooking utensils, tea kettles or any other object on top of heater while in operation.
4. To avoid possible burns or fire, do not move, refuel or attempt to service your heater while it is burning or still hot. If the heater is dropped while it is burning, fuel spillage and flames outside the heater may occur.
5. Do not operate heater less than one (1) meter from walls, draperies, clothing, or furniture. The operation of any heating appliance too close to such materials could cause them to ignite, possibly resulting in a serious fire.
6. To avoid unstable burning, do not operate your heater in areas exposed to strong drafts. Do not operate heater in high-traffic areas such as doorways or hallways where it may be touched, jarred or tipped accidentally.
7. Do not operate heater in direct sunlight to avoid overheating, which may cause abnormal flame behavior. Do not allow room temperature to go above 25°-30°C. If the room temperature exceeds 25°-30°C the flame may increase, thereby producing smoke.
8. Before going out, or at bedtime, turn the heater off, making sure the wick is in its lowest position (see Extinguishing the Flame on page 8) and flame is completely extinguished.
9. This appliance can be used by children aged from 8 years and above and persons with reduced physical, sensory or mental capabilities or lack of experience and knowledge if they have been given supervision or instruction concerning use of the appliance in a safe way and understand the hazards involved.
10. Children shall not play with the appliance.
11. Cleaning and user maintenance shall not be made by children without supervision.

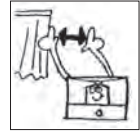

WARNING

RISK OF INDOOR AIR POLLUTION

Use heater only in well-ventilated areas. People with breathing problems should consult a physician before using the heater.

"In a house of typical construction, that is, one that is not of unusually tight construction due to heavy insulation and tight seals against air infiltration, an adequate supply of air for combustion and ventilation is provided through infiltration. However, if the heater is used in a small room where less than 200 cubic feet (5.7m³) of air space is provided for each 1000 Btu per hour of heater rating (considering the maximum burner adjustment), the door(s) to adjacent room(s) should be kept open or a window to the outside should be opened at least 1 inch (25.4 mm) to guard against potential buildup of indoor air pollution. Do not use the heater in a bathroom or any other small room with the door closed."

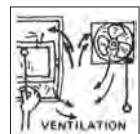

FUEL GUIDE

The RCA-2800 is designed for use with high-quality kerosene (paraffin). Use of low-quality kerosene (paraffin) will cause wick performance to drop, leading to “low flame” and “odor problem” conditions. The kerosene (paraffin) commonly known as “industrial kerosene (paraffin)” is not suitable for your heater. Purchase only kerosene (paraffin) in non-red cans reserved exclusively for kerosene (paraffin) and marked accordingly with the word “KEROSENE (PARAFFIN)”. Always store your kerosene (paraffin) in a separate area from where you store gasoline (petrol) for your power equipment, to avoid accidental use of gasoline (petrol) in your heater.

What to Buy...

- ALWAYS: Crystal clear, high quality KEROSENE (PARAFFIN).
- ALWAYS: Kerosene (paraffin) free of contaminants, water or cloudiness.
- NEVER: Gasoline (petrol), alcohol, white gas, camp stove fuel or additives.
- NEVER: Yellow or sour-smelling fuel.



How to Use It...

- ALWAYS: Fill heater away from living quarters when heater is cool; use siphon.
- ALWAYS: Check wick frequently for tar build-up. (Rapid, heavy build-up may indicate poor quality or deteriorated fuel.)
- ALWAYS: Watch fuel gauge to avoid over-filling heater.



How to Store It...

- ALWAYS: In a clean container, clearly marked KEROSENE (PARAFFIN).
- ALWAYS: Store away from direct sunlight, heat sources or extreme temperature changes.
- NEVER: In a glass container, or one that has been used for other fuels.
- NEVER: For longer than 6 months. (Begin each heating season with fresh kerosene (paraffin); discard at the end of the season.)
- NEVER: Accidental introduction of water into fuel containers.



Why It is Important...

Pure, clean kerosene (paraffin) is essential for safe and efficient heater operation. Poor quality or contaminated kerosene (paraffin) can cause:

- Low flame
- Excess tar deposits on the wick
- Reduced wick life
- Odor, smoke
- Difficulty in igniting or extinguishing flame

Use of a highly volatile flammable fuel such as gasoline (petrol) can produce uncontrollable flames, creating a severe fire hazard.



CAUTION

Flames observed emerging from the heater body are a clear indication that fuel is dangerously contaminated with gasoline (petrol) or other highly flammable material. If this occurs,

- a. Never attempt to move the heater.
- b. Call the Fire Department.
- c. Use only a class “B” fire extinguisher.
- d. Never throw water directly on a burning heater.

ASSEMBLY AND OPERATION

INSPECTION AND ASSEMBLY

NOTE: Please save the shipping carton packing materials for future storage of your heater.

1. REMOVE PACKING MATERIALS

Open the grille by raising the lower right hand corner of grille and pulling straight out. Remove the styrofoam packing wedge from under the top plate of cabinet to release the heat chamber assembly. Lift the heat chamber, in its protective packing, out of the cabinet.

2. REPLACE THE HEAT CHAMBER

Remove the cardboard packing, and replace the heat chamber assembly. Point the wire handle to the front of the heater.

Close the grille.

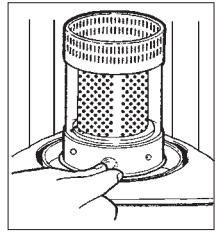
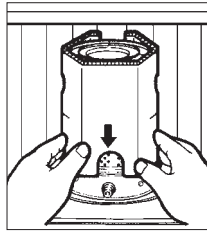
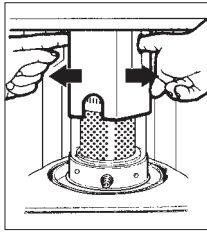
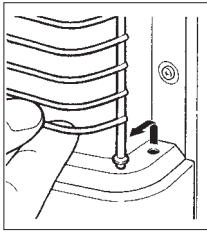

3. INSTALL THE BATTERIES

Locate the battery holder on the back of your heater.

- Insert the battery 2 "D" size batteries according to the plus (+) and minus (-) markings.

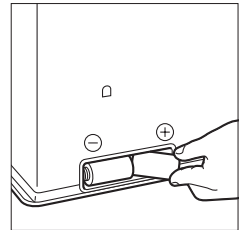

4. CHECK THE HEAT CHAMBER

If the chamber is raised, put it down and inlay it.

NOTE: If the heat chamber is raised, it can cause smoke and soot.

FUELING

WARNING: Use only clean kerosene (paraffin).

Never use gasoline (petrol) or other flammable liquids.

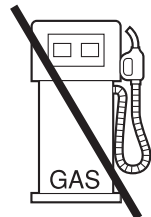

1. Open the fuel tank lid on the top of heater cabinet and lift out the removable fuel tank. Turn the removable tank upside down and remove the fuel tank cap.
2. Insert the straight tube of the manual siphon into the kerosene (paraffin) container. Insert the siphon's flexible hose into the removable fuel tank opening.
3. Turn the air vent knob on the top of the siphon clockwise to close the vent. Start the flow of kerosene (paraffin) by squeezing the bulb of the siphon vigorously six or seven times. Once flow begins, it is no longer necessary to squeeze the bulb.
4. Watch the fuel gauge on the removable tank to avoid overfilling. When it shows half, stop flow by turning the air vent knob counterclockwise.

NOTE: Be careful to avoid overfilling the tank, especially with very cold kerosene (paraffin). Overflow might occur due to expansion when the fuel warms up.

5. Remove the siphon carefully, allowing excess kerosene (paraffin) to drain from the tube back into the container. replace fuel tank cap and tighten it securely. Be sure to wipe away any spilled kerosene (paraffin) from tank and other heater parts.
6. After making sure fuel tank cap is tightly fastened, invert tank and replace into heater body.

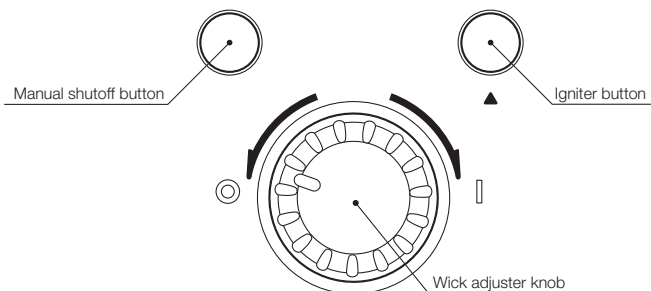
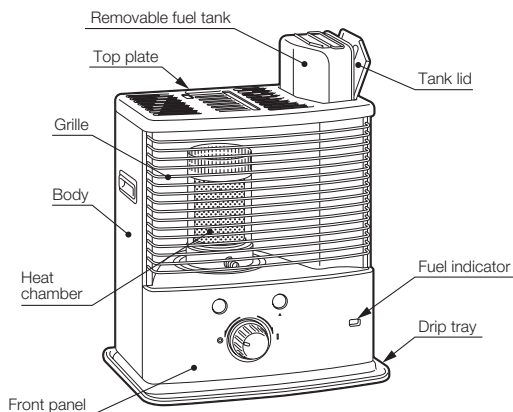
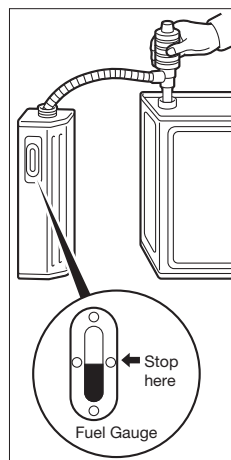

CHECK BEFORE LIGHTING

1. LEVEL THE HEATER

The heater should be operated on a firm, level floor.

NOTE: If your heater is not level, change locations.
Do not prop it with books or other objects.

2. ENGAGE THE AUTOMATIC EXTINGUISHER

The automatic extinguisher is engaged automatically by turning the wick adjuster knob clockwise.

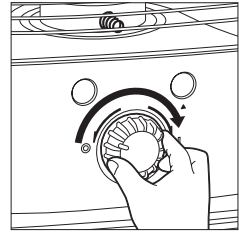

NOTE: When it is difficult to engage the automatic extinguisher, turn the wick adjuster knob counterclockwise once until it stops. And then turn the wick adjuster knob clockwise.

LIGHTING

NOTE: When you first use your new heater, ignite it out of the living area of your house, either in a garage or an area outside protected from strong drafts. Burn it for about 15 minutes to remove all of the protective oil present on the burner parts. If this 15 minutes “burn-in” is done inside, some objectionable odor will be observed. This procedure is necessary **ONLY THE FIRST TIME** you ignite your heater.

NOTE: If you have fueled your heater for the first time, or if you are refueling it after it has been out of fuel for a long time, you will need to wait about thirty (30) minutes for the wick to become fully saturated.

1. Turn the wick adjuster knob clockwise until it stops.

As the wick rises within the heater, the wick adjuster knob turns with some resistance and makes a sound like the winding of a clock. Once the wick has reached its proper height, the automatic extinguisher is fully engages.

The wick adjuster knob can now move freely left or right to adjust the flame.

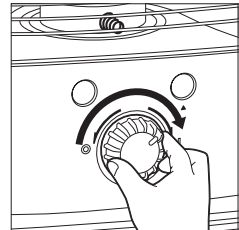

2. AUTOMATIC LIGHTING

Gently push the igniter button, the igniter coil should glow and touch the wick.

NOTE: If you have difficulty igniting wick, push back the igniter button very slightly to remove the igniter coil from direct contact with the wick.

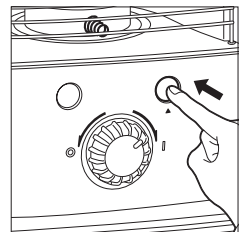

3. LIGHTING WITH MATCH

You should not have to light the heater with a match, but should it become necessary, open the grille, lift the heat chamber up by holding the wire handle and touch the match to the top of the wick. Do not allow burned parts of the match to fall or remain on the wick.

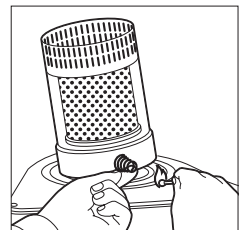

NOTE: To restore the automatic igniter system to proper operation, replace worn out batteries, or if the igniter coil defective, replace it.

4. Be sure that heat chamber is properly seated by moving the wire handle left and right. If the movement is cough and jerky, it indicates that the heat chamber has not seated properly.

NOTE: An improperly seated heat chamber can cause high flame, smoke, and potential damage to the heater itself. Do not leave the heater until you have determined that the flame is burning normally, will be described in the following section.

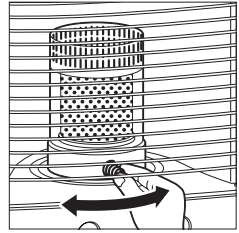

ADJUSTING THE FLAME

1. After lighting wait for the heat chamber to reach operating temperature. This will take several minutes, then the flame will be visible.
2. CHECK THE FLAME HEIGHT
After five minutes, the entire heat chamber should be glowing red.

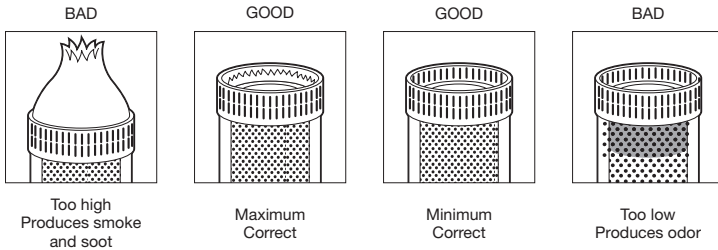

If necessary, raise or lower the wick by turning the wick adjuster knob to produce the proper flame condition.

NOTE: Do not operate your heater wick set TOO LOW or TOO HIGH. Doing so will decrease combustion efficiency and increase production of unwanted emissions. When operating heater, be sure wick is high enough to keep the primary heat chamber heated to a uniform red glow from its top to bottom.

3. ADJUSTMENT OF MAXIMUM WICK HEIGHT

After using the heater over a long period of time, you may observe that the flame length in heat chamber does not reach its normal level in several minutes after lighting. When this condition is observed, it means that the wick height needs adjusting the unique wick life extender.

To adjust the wick height using the wick life extender mechanism, first release the automatic extinguisher by pushing the manual shutoff button.

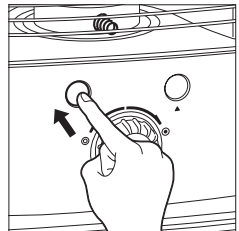

Pull the wick adjuster knob out completely. (It can be removed completely from its shaft.)

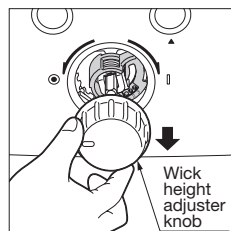

The wick height adjuster knob, with three small holes marked ①, ②, and ③, can be seen. The stem pin is engaged in one of the holes. Pull the control dial toward you and change the location of the pin from ① to ②, or from ② to ③. Each step from pin ① to ② will raise the maximum wick height by 2 mm per step. After this adjustment, replace the wick adjuster knob.

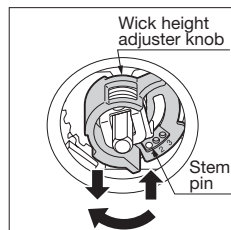

When suitable flame length can no longer be achieved even on pin position ③, it is time to clean and replace the wick. AFTER REPLACING THE WICK, CHECK THE OPERATION OF THE AUTOMATIC EXTINGUISHER BEFORE LIGHTING YOUR HEATER.

NOTE: Never use positions ② or ③ until position ① no longer gives adequate flame length.

EXTINGUISHING THE FLAME

1. Turn the wick adjuster knob counterclockwise until it stops. This requires about a quarter turn. At this point, the flame is completely extinguished and the heater is off.

NOTE: DO NOT use the automatic extinguisher to routinely turn off this heater. Automatic extinguishing should occur only when the heater is jarred or tipped. Using the automatic extinguisher to turn off the heater will cause odor, smoke and soot.

2. Make sure the flame is out completely.
3. Do not try to relight the heater for at least three (3) minutes extinguishing it off as this may cause smoke and odor.

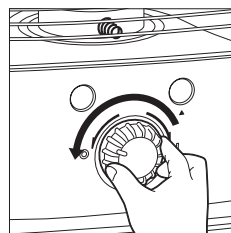

MANUAL SHUTOFF

When quick shutoff is necessary, push the manual shutoff button.

NOTE: For routine turn-off, DO NOT use the Manual Shutoff or activate the Automatic Extinguisher by jarring the heater. These methods may cause unwanted odor, soot and smoke. Only the wick adjuster knob should be used for normal shutoff.

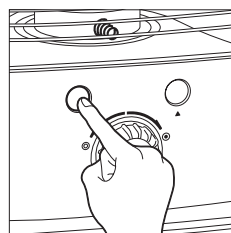

ASSEMBLY AND OPERATION

REPLACING THE WICK

WARNING: Before disassembling your heater, allow it to cool completely.

1. To release the automatic extinguisher, push the manual shutoff button.

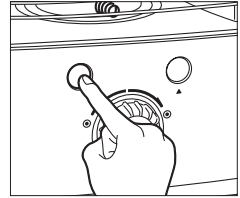

2. After the heat chamber has cooled completely, open the grille and remove the heat chamber.

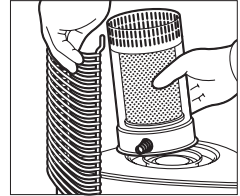

3. Grasp the wick adjuster knob and pull it straight off the wick adjuster shutoff.

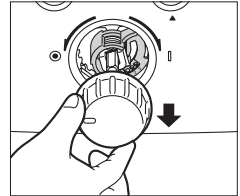

4. Remove the batteries from the battery holder.

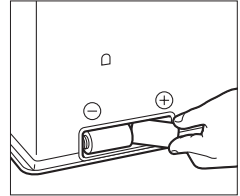

5. Lift out the removable fuel tank and set it aside.
Remove the three (3) screws at the side and rear of the cabinet by using the screwdriver, and lift the cabinet off, bringing it slightly forward.

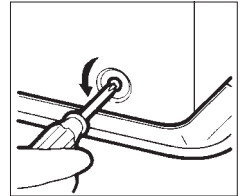

6. Remove the four (4) wing nuts around the wick adjuster assembly.
Lift the assembly off the heater.

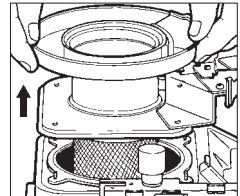

7. Remove the screw on the stem holding the bracket and remove the bracket, spring and wick height adjuster knob.

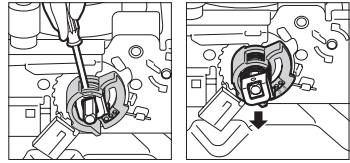

8. Turn the stem clockwise until it stops and remove the wick sleeve with wick.

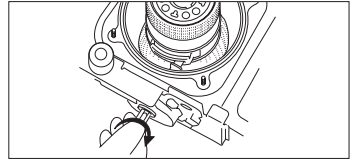

9. Turn the wick sleeve counterclockwise and lift the wick sleeve with wick up. Remove it from the primary air tube.

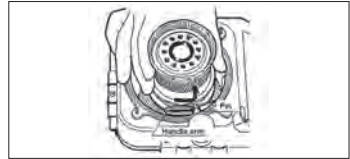

10. Squeeze the wick to loosen the three pins and remove the wick from the wick sleeve.

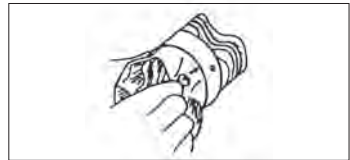

11. Install the wick to the wick sleeve according to the allowed direction engraved on the wick sleeve.

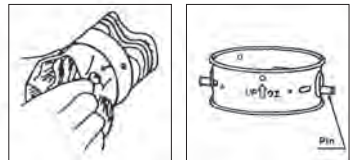

12. Install the wick sleeve with wick to the primary air tube. And then turn the wick sleeve clockwise to set the handle arm.

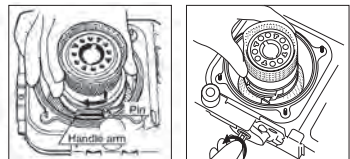

13. Install the wick height adjuster knob, spring and bracket. The wick position should be adjusted at No.1. Then tighten the screw which is holding the stem.

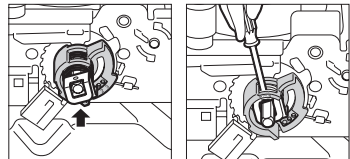

14. Put the wick adjuster back into position.

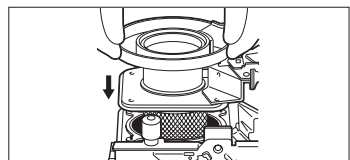

NOTE: The space between the wick adjuster and the primary air tube should be even all around.

NOTE: Make certain the top of the wick adjuster and the top of primary air tube are the same height. If they are uneven, the flames tend to be uneven, too.

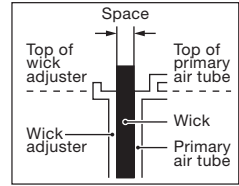

15. Tighten the four (4) wing nuts around the wick adjuster.

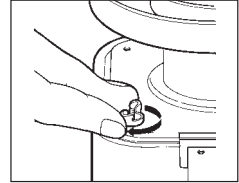

16. Operate the wick adjuster knob to be sure the wick moves smoothly up and down.

AFTER REPLACING THE WICK, CHECK THE OPERATION OF THE AUTOMATIC EXTINGUISHER.

Wick height on position ① of wick life extender should be 10 mm, when wick adjuster knob is fully clockwise. Be sure to check.

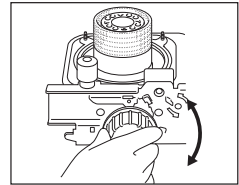

NOTE: Remember always start new wick on position ① of wick life extender.

NOTE: If wick does not move smoothly and easily, or wick height is more or less 10 mm, do not use heater, disassemble and repeat items 11 through 16.

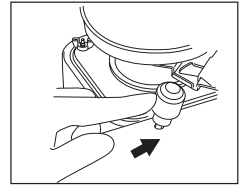

NOTE: If any ragged edges appear on the top of the wick, trim them with a scissors carefully. DO NOT cut the body of the wick.

Remove the wick adjuster knob from the wick adjuster shaft once more.

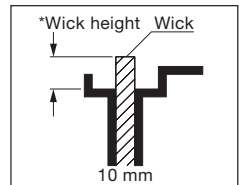

17. Replace the cabinet and secure it into position with three (3) screws.

Replace the wick adjuster knob on the wick adjuster shaft. Install the heat chamber. Grasp the wire handle, then turn the heat chamber left and right to insure that it is properly seated. Once again check the proper operation of the automatic extinguisher.

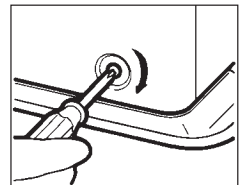

NOTE: Before lighting a new wick for the first time, turn the wick to its lowest position. Allow the wick to saturate with kerosene for thirty (30) minutes.

18. Put the batteries into the battery holder.

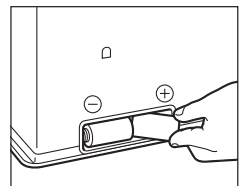

REPLACING THE IGNITER COIL

WARNING: Before replacing the igniter coil, allow the heater to cool completely.

1. FIRST CHECK THE BATTERIES

When the igniter coil no longer glows sufficiently to light the wick, replace the batteries. If proper glow is not restored, the igniter coil may be defective.

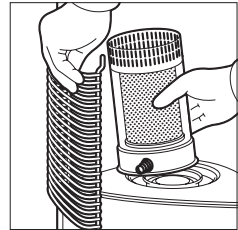

2. CHANGE THE IGNITER COIL

Remove the batteries from the battery holder.

Release the automatic extinguisher, and remove the heat chamber as described in Items 1 and 2 of the preceding section.

Note that the igniter coil fits into a bayonet socket the same way a flashlight bulb fits into its holder.

To remove the igniter coil, push it in and twist in either direction while holding the sides of the socket with your other hand.

Install the new igniter coil by pressing it into the socket and turning.

Replace the heat chamber, and reinstall the batteries.

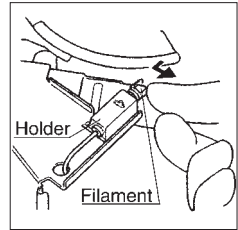

STORAGE

At the end of each heating season, or when you do not plan to use your heater for an extended period of time, the following procedures are recommended:

1. DRAIN FUEL SUB TANK

After you have burned your heater dry, a small amount of kerosene (paraffin) will remain in the fuel sub tank. It should be removed in order to avoid contamination when the heater is refueled at a later date. To do this, disassemble the heater as described in items 1 through 4 under "REPLACING THE WICK". Remove the fuel acceptance fitting from the hole in the fuel sub tank.

Tilt the drip tray toward the hole, and remove the remaining kerosene (paraffin) with a siphon or a small syringe.

Replace the fuel acceptance fitting.

Replace the cabinet and the heat chamber.

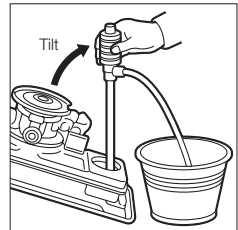

2. REMOVE BATTERIES FROM BATTERY HOLDER

3. STORE HEATER

The original shipping carton is the best place to store your heater. If you do not have original packing materials, cover the heater with a large plastic bag and store in a dry place.

SPECIFICATIONS

Heat rating	Model RCA-2800 (Type B)
Fuel tank capacity	10,000 BTU/h (2,530 kcal/h)
Burning time / tank*	3.6 l
Size (W × D × H)	17 Hours
Weight	428 × 295 × 453 mm
Wick adjuster	7.6 kg
Igniter	Wick life extender mechanism
	Automatic, powered by two (2) "D" size batteries

* Depending on wick setting, condition and fuel quality.

COMPONENT PARTS

REF #	PART NAME
1.	Tank lid
2.	Top plate
3.	Grille
4.	Heat chamber assembly
5.	Glass cylinder
6.	Removable fuel tank
7.	Fuel tank cap
8.	Wick adjuster assembly
9.	Igniter unit
10.	Igniter coil
11.	Pendulum assembly
12.	Wick adjuster knob
13.	Glass fiber wick
14.	Wick sleeve
15.	Rubber packing
16.	Fuel sub tank
17.	Fuel acceptance fitting
18.	Drip tray
19.	Battery holder
20.	Manual fuel siphon

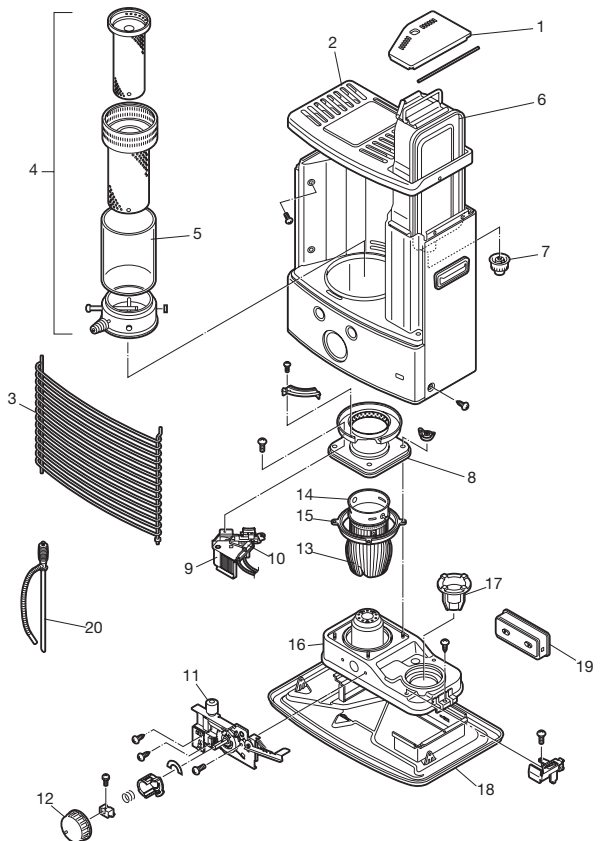



Disposal of old Electrical & Electronic Equipment (Applicable in the European Union and other European countries with separate collection systems).

This symbol on the product or on its packaging indicates that this product shall not be treated as household waste. Instead it shall be handed over to the applicable collection point for the recycling of electrical and electronic equipment. By ensuring this product is disposed of correctly, you will help prevent potential negative consequences for the environment and human health, which could otherwise be caused by inappropriate waste

handling of this product. The recycling of materials will help to conserve natural resources. For more detailed information about recycling of this product, please contact your local city of. ce, your household waste disposal service or the shop where you purchased the product.

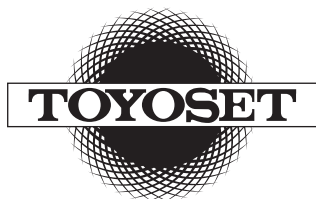

TÖYÖTÖMI

TOYOTOMI CO., LTD.

5-17, Momozono-cho
Mizuho-ku, Nagoya, Japan
www.toyotomi.jp

Rev. 07/14

Printed in Japan
8414000903